

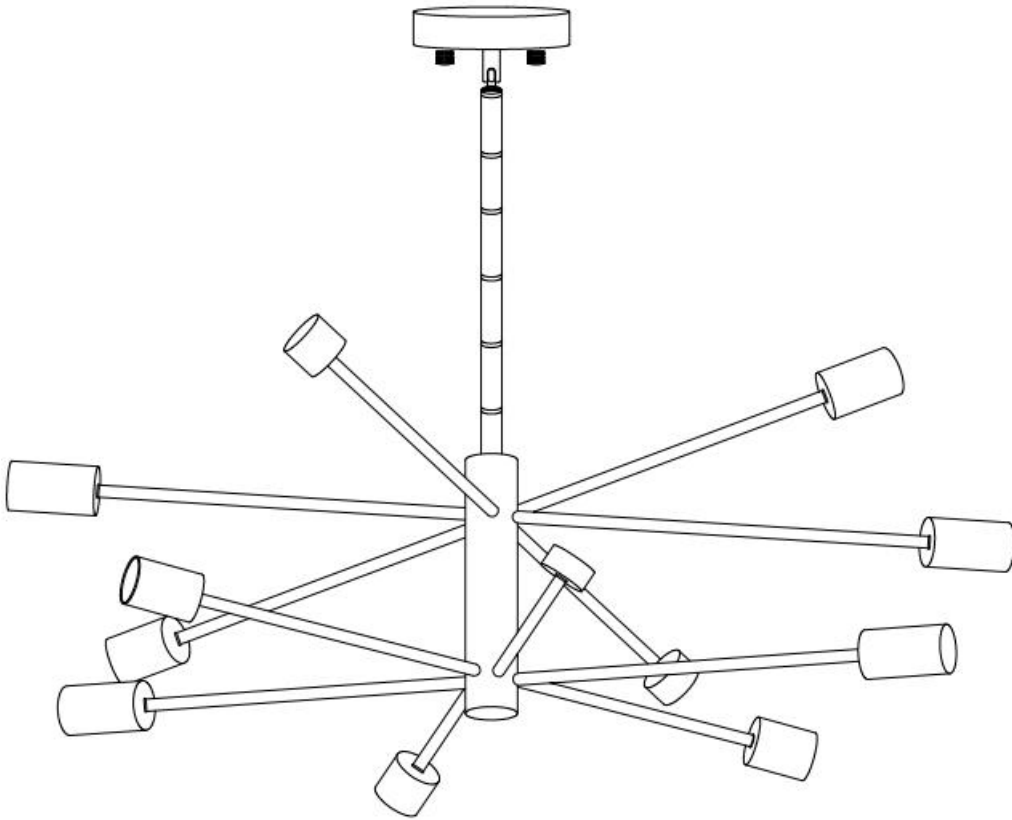

# User Manual



Size: 730\*1220mm

 Email: [hmled\\_service@outlook.com](mailto:hmled_service@outlook.com)

## Start from Here

- Make sure POWER is completely OFF at the fuse box .
- Have your fixture installed by a qualified licensed electrician.
- Prepare everything in a clear and soft area for there is glass parts.
- Wear gloves at all time during this installation.
- Read instructions carefully before you start assembly.
- Keep this installation sheet for future reference.
- When you open the package with sharp tools, be careful not to damage the accessories inside.
- Please use the bulb of E26 socket to avoid damaging the circuit.

## Please Note





- Do not plug in the product if the cord is broken or frayed.
- Do not over-tighten screws and bolts as this may damage the threads.
- Do not use abrasive cleaners, clean with a soft cloth and mild detergent.
- Please use a bulb of appropriate size to avoid damaging the lamp shade.
- Do not let children play with this product, keep away from children.

## Parameter

Voltage [ V ]	Frequency [ Hz ]	Power [ W ]
120V	50/60	60

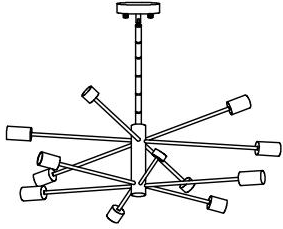
# PACKAGE INCLUDED

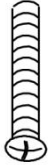
*Before you begin, make sure the package contains the following components!*

 <p>Lamp Body</p>	A: X1	 <p>Mounting plate</p>	B: X1
 <p>Washer</p>	C: X2	 <p>Screw</p>	D: X2
 <p>Wire Nut</p>	E: X3	 <p>Screw Nut</p>	F: X2

Some parts will be sent 1-2 pieces more than required for installation to prevent parts from being lost or damaged.

# Installation Guide

Turn off all the power first before any installation!!

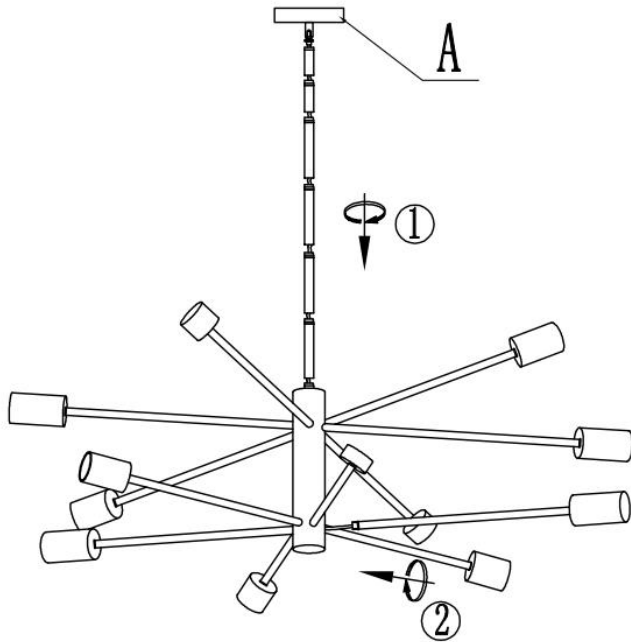

1. Rotate Clockwise to install the Adjustable Rods, lightly tighten;

Untie the wires and remove the rods to adjust the height;

2. Rotate Clockwise to install the light Poles.

(To prevent the wire from being damaged by Rotation, first turn counterclockwise for 3 turns)

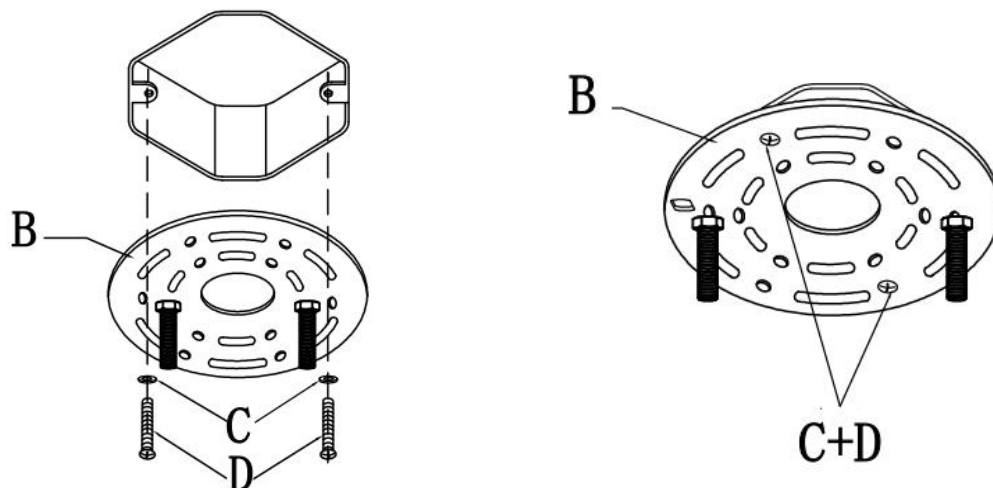

3. Turn **off** the **Power** first, Attach Mounting Plate (**B**) base to electrical junction box using Head Screws(**D**) and Washers (**C**) provided in hardware package.

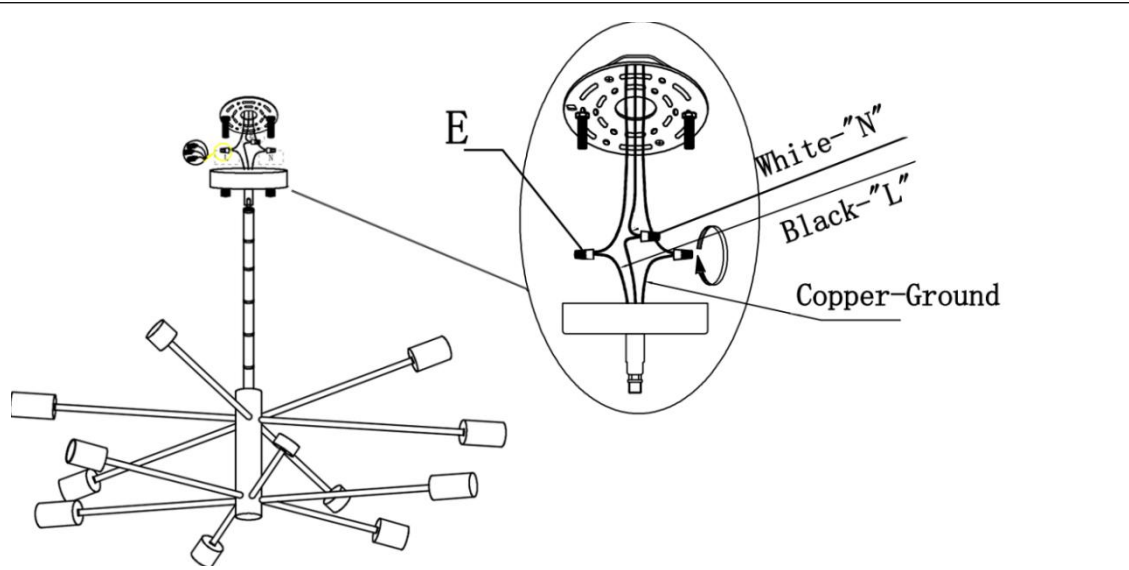

4. Make proper electrical connections with Wire nuts (**E**);
- Black Wire to hot "L", White Wire to neutral "N";
  - Copper Wire to "Ground".

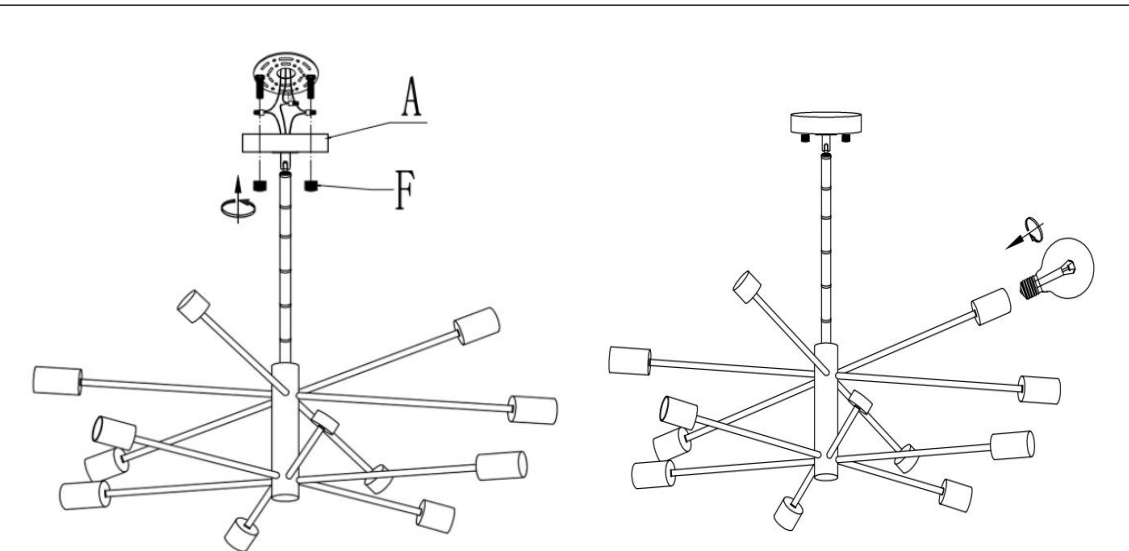

5. Reinstall Lamp Body (**A**) to the Mounting Plate (**B**) with Screw Nuts (**F**);
6. Install the light bulbs and finish.